

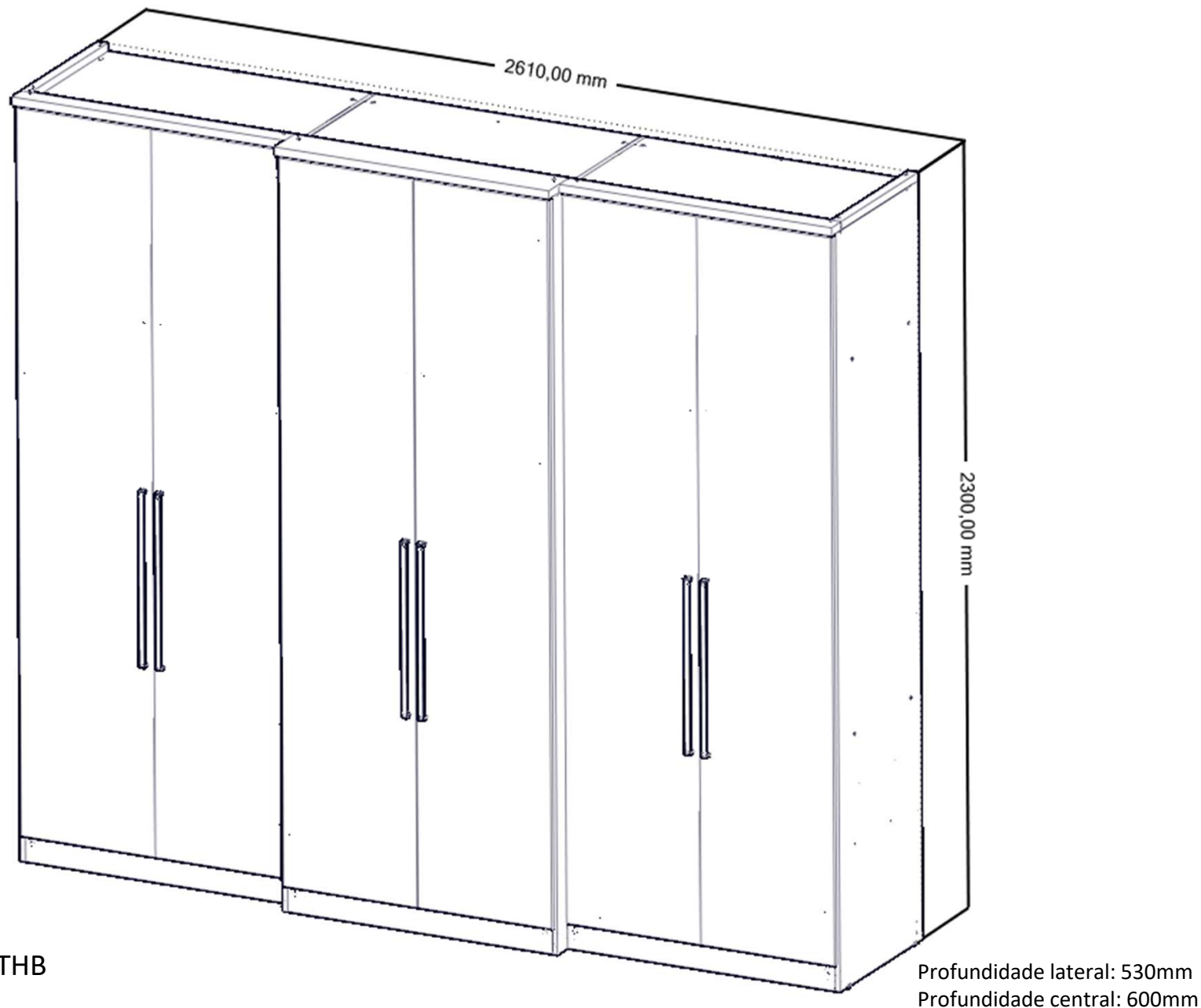

## Roupeiro Baviera 6P













 @moveisTHB

 @moveisthb

 Indústria de Móveis THB

 [www.moveisthb.com.br](http://www.moveisthb.com.br)

## Roupeiro Baviera 6P | Wardrobe Baviera 6P | Armario Baviera 6P

Ferragem	Ref.	Cód. Assist. Capuccino	Cód. Assist. Rustic	Descrição	Description	Descripción	Quantidade									
									S	24648	24648	Parafuso 3,5x25 CF (usar nos puxadores)	3,5x25 cf screw (use in handles)	Tornillo de 3,5x25 CF (use en manijas)		12
	A	37091	37091	Perfil h 2190mm	Profile h 2190mm	Perfil H 2190 mm	2		T	36919	36919	Gabarito Cabideiro	Templet coat	Plantilla Percha		1
	B	29242	29242	Parafuso 3,5x35 CF	3.5x35 cf screw	Tornillo de 3.5x35 cf	22		U	39258	39258	Dobradiça c  Calço c  Amort. Curva	Mini curve hinge	Bisagra de mini curva		16
	C	39255	39255	Distanciador Gaveta	Distancer Drawer	Cajón del distanciador	16		V	39222	39222	Dobradiça c  Calço c  Amort. Super Curva	Super curved hinge	Bisagra super curva		8
	D	37893	37893	Cabideiro Obl. 842mm	Obl Hangers. 842mm	Obl Hangers.	2		X	36611	36611	Suporte Cabideiro	Coat Support	Soporte Percha		4
	E	34125	34125	Parafuso 3,5x14 CP ZB	3.5x14 CP ZB screw	3.5x14 Tornillo ZB CP	32		Y	36723	36723	Parafuso 3,5x12 CC (emb. c/ suporte cab.)	Screw 3.5x12 cc (Emb. C/ support Cab.)	Tornillo 3.5x12 CC (Emb. C/ Cabas de soporte)		8
	F	33663	33663	Parafuso 3,5x14 CP	3.5x14 cp screw	3.5x14 tornillo CP	108		Z	24099	24099	Presilha	Clip	Presilha		66
	G	25673	25673	Parafuso 4,0x14 CC	4.0x14 cc screw	4.0x14 tornillo CC	160		AA	31077	391035	Sapata Plástica	Plastic shoe	Zapata de plástico		8
	H	36013	36013	Suporte Prateleira	Shelf support	Soporte de estante	16		AB	36724	36724	Sachê de Cola	Cola sachet	Bolsita del pegamento		2
	I	25691	25691	Parafuso Soberbão 7,0x40CC	Superb screw 7.0x40cc	Excelente tornillo 7.0x40cc	16		AC	31363	31363	Logo THB	Logo THB	Logotipo THB		1
	J	25679	25679	Parafuso Minifix	Minifix screw	Tornillo de minifijo	28		AD	36012	36012	Tampa Tambor	Drum lid	Tapa del tambor		32
	K	25675	25675	Parafuso Minifix Haste Dupla	Double -rod minifix screw	Tornillo de minifijo de doble banda	8		AE	36014	36014	Tampa Soberbão Cinza Social	Superb lid Cinza Social	Tapa Soberbão Cinza Social		8
	L	22388	22388	Tambor Minifix	Minifix drum	Tambor minifijo	44		AF	31078	39101	Tampa Soberbão	Superb lid	Tapa Soberbão		8
	M	24603	24603	Cavilha 6,0x30	6,0x30 Peg	Clavija 6,0x30	44		AG	34586	39105	Tapa Furo 5mm	5mm hole Tapa	Tapa agujero 5mm		16
	N	20179	20179	Prego	Nail	Clavo	170		AH	25678	25678	Suporte Vidro (Versão Glass)	Glass Support (Glass Version)	Soporte de vidrio (Versión de vidrio)		4
	O	30094	30094	Suporte Trianglar	Trianglar support	Soporte de Trianglar	8		AI	34125	34125	Parafuso 3,5x14 CP ZB (Versão Glass)	Screw 3.5x14 CP ZB (Glass Version)	Tornillo 3,5x14 CP ZB (Versión Glass)		4
	P	36952	36952	Trilho Telescópico	Telescopic rail	Ferrocarril telescópico	4		AJ	25678	25678	Suporte Vidro (Versão Full Glass)	Glass Support (Full Glass Version)	Soporte de vidrio (versión de Full Glass)		12
	Q	36010	36010	Cantoneira Plástica	Plastic singer	Cantante de plástico	16		AK	34125	34125	Parafuso 3,5x14 CP ZB (Versão Full Glass)	Screw 3.5x14 CP ZB (Full Glass Version)	Tornillo 3,5x14 CP ZB (Versión Full Glass)		12
	R	37847	37847	Puxador Less 512mm	Less 512mm handle	Manija Less 512mm	6									

Ref.	Cód. Capuccino  Code Capuccino  Cód. Capuccino	Cód. Rustic  Code Rustic  Código Rustic	Descrição	Description	Descricion	Comprimento  Length  Longitud	Largura  Width  Ancho	Espessura  Thickness  Espesor	Quantidade  The amount  Cantidad
1	P19324	P19257	Lateral Esquerda	Left side	Lado izquierdo	2276	514	15	1
2	P19323	P19256	Lateral Direita	Right side	Lado derecho	2276	514	15	1
3	P19326	P19257	Divisão Esquerda	Left Division	División Izquierda	2276	578	15	1
4	P19325	P19258	Divisão Direita	Right Division	División derecha	2276	578	15	1
5	P19260	P19260	Divisão Central	Central Division	División Central	2158	450	15	1
6	P19261	P19261	Tampo Inf. Lateral	Top Bottom Side	Superior Inferior Lado	854	514	15	2
7	P19262	P19262	Tampo Inf. Central	Top Bottom Central	Tapa inferior Central	845	578	15	1
8	P19263	P19263	Tampo Sup. Lateral	Top Cover Side	Tapa Superior Lado	854	514	15	2
9	P19264	P19264	Tampo Sup. Central	Top Cover Central	Tapa Superior Central	845	578	15	1
10	P19265	P19265	Tampo Interm. Lateral	Intermediate Top Side	Tapa Interm. Lado	854	450	15	2
11	P19266	P19266	Tampo Sup. Gaveta	Upper drawer top	Tapa Superior Cajón	854	450	15	2
12	P19267	P19267	Tampo Interm. Central	Intermediate Top Central	Tapa Interm. Central	415	450	15	4
13	P19361	P19361	Prateleira Central	Central Shelf	Estantería Central	415	450	15	4
14	P19327	P19268	Frente Pé Lateral	Side foot front	Frontal del pie lateral	854	88	15	2
15	P19328	P19269	Frente Pé Central	Central Foot Front	Frente central	845	88	15	1
16	P19270	P19270	Traseiro Pé Lateral	Side foot	Pie lateral	854	88	15	2
17	P19271	P19271	Traseiro Pé Central	Rear central foot	Pie central trasero	845	88	15	1
18	P19329	P19277	Moldura Sup. Menor	Smaller Higher Frame	Moldura Sup. Menor	479	30	25	2
19	P19330	P19278	Moldura Sup. Lateral	Side Higher Frame	Moldura Sup. Lado	869	60	25	2
20	P19331	P19279	Moldura Sup. Central	Central Higher Frame	Moldura Sup. Central	875	124	25	1
21	P15871	P15871	Lateral Gaveta	Side drawer	Cajón	385	88	15	8
22	P19272	P19272	Traseiro Gaveta	Rear drawer	Cajón trasero	769	88	15	4
23	P19274	P19274	Fundo Gaveta	Drawer background	Fondo de cajón	767	406	2,5	4
24	P19273	P19273	Frente Gaveta	Drawer front	Frontal del Cajón	780	149	15	4
25	P19275	P19275	Fundo Lateral Maior	Larger side bottom	Fondo lateral más grande	2190	432	2,5	4
26	P19276	P19276	Fundo Central Menor	Smaller central background	Fondo central más pequeño	2190	430	2,5	2
27	P19253	P19252	Porta	Door	Puerta	2186	426	15	6
28	39190	39190	Espelho Full Glass	Full Glass Mirror	Espejo Full Glass	1090	390	3	2
29	39191	39191	Espelho Menor Full Glass	Full Glass Smaller Mirror	Espejo Full Glass Menor	545	390	3	4
30	30919	30919	Espelho Glass	Mirror Glass	Espejo Glass	1348	350	3	2

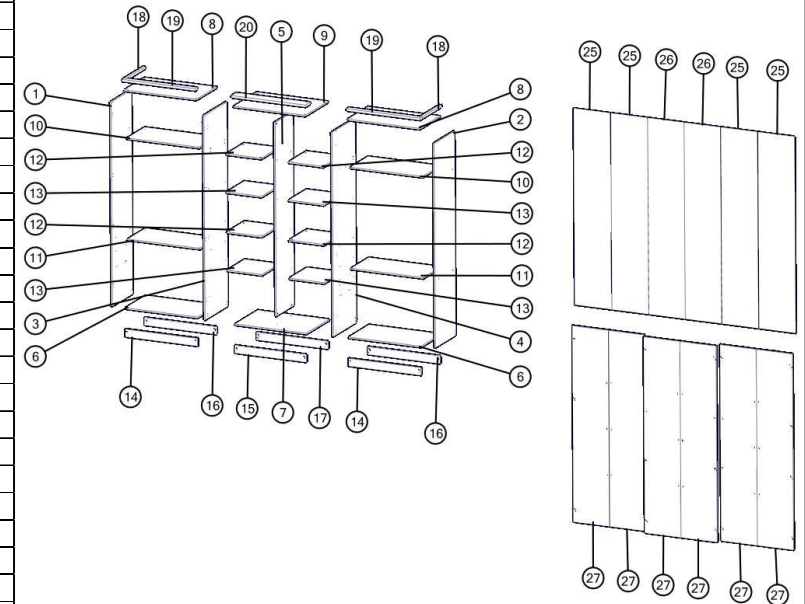

### ATENÇÃO|ATTENTION|ATENCIÓN

- 1 - Antes de montar o móvel, leia o manual com atenção.  
Before assembling the furniture, read the manual carefully.  
Antes de montar el mueble, lea atentamente el manual.
- 2 - Recomenda-se que a montagem seja realizada de acordo com o manual.  
It is recommended that assembly be carried out in accordance with the manual.  
Se recomienda realizar el montaje de acuerdo con el manual.
- 3 - Certifique-se que a base onde o produto será montado está limpa e plana.  
Make sure the base where the product will be mounted is clean and flat.  
Asegúrese de que la base donde se montará el producto esté limpia y plana.



Atenção com a cor do acabamento!  
Em caso de assistência solicitar o código de acordo com a cor da peça.  
Pay attention to the finish color!  
In case of assistance, request the code according to the color of the part.  
Presta atención al color del acabado!  
En caso de asistencia solicitar el código según el color de la pieza.

Passo 01 | Step 01 | Paso 01

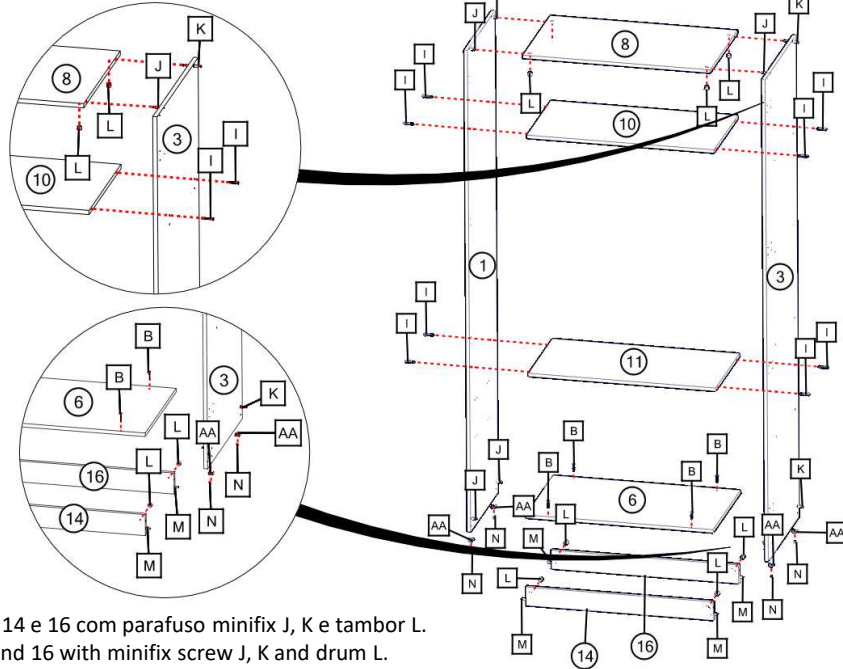

Fixar os pés 14 e 16 com parafuso minifix J, K e tambor L.  
 Fix feet 14 and 16 with minifix screw J, K and drum L.  
 Fijar los pies 14 y 16 con tornillo minifix J, K y tambor L.

Passo 02 | Step 02 | Paso 02

Fixar os tampos 10 e 11 com parafusos soberbão I.  
 Fix the tops 10 and 11 with screws I.  
 Fije las tapas 10 y 11 con tornillos I.

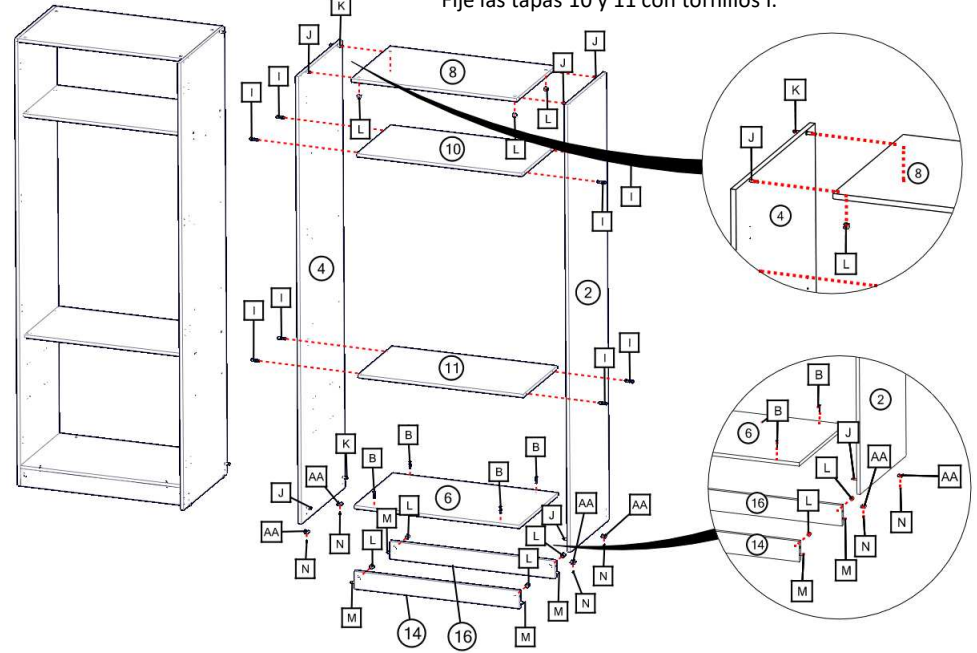

Passo 03 | Step 03 | Paso 03

Fixar os tampos 9 e 12 com parafuso minifix J, K e tambor L.  
 Fix the tops 9 and 12 with minifix screw J, K and drum L.  
 Fijar las tapas 9 y 12 con tornillo minifix J, K y bidón L.

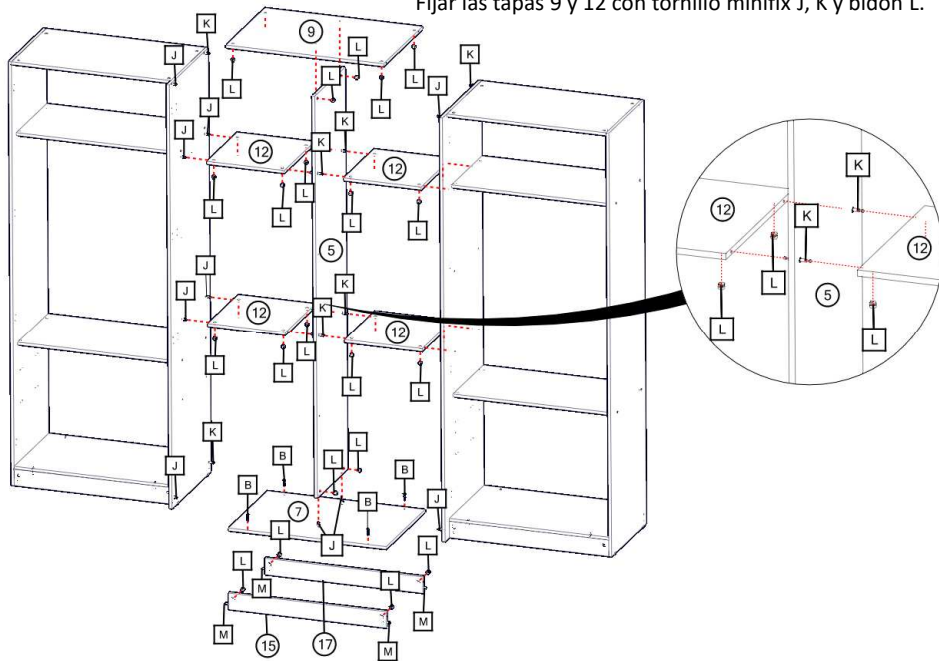

Passo 04 | Step 04 | Paso 04

Fundo Central 26 está riscado de vermelho e fundo lateral 25 riscado de preto.  
 Central background 26 is scratched in red and side background 25 is scratched in black.  
 El fondo central 26 está rayado en rojo y el fondo lateral 25 está rayado en negro.

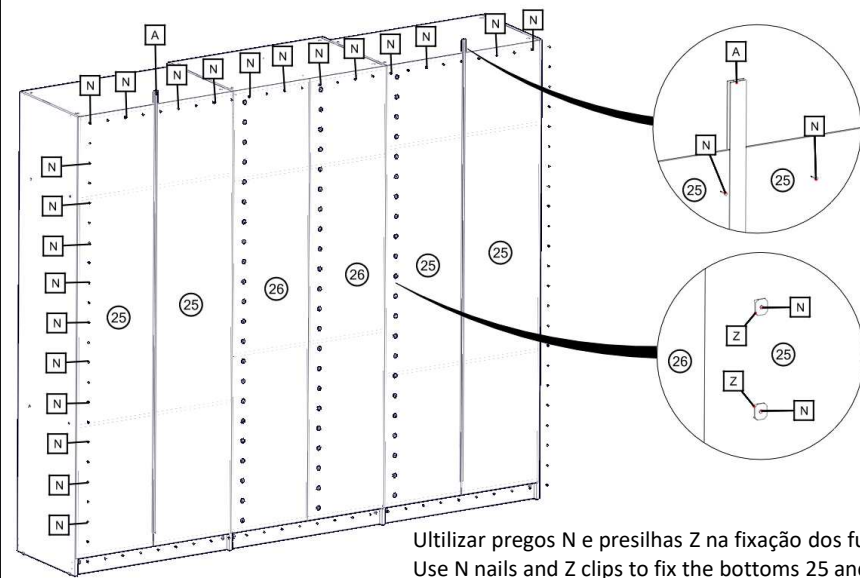

Utilizar pregos N e presilhas Z na fixação dos fundos 25 e 26.  
 Use N nails and Z clips to fix the bottoms 25 and 26.  
 Use clavos N y clips Z para fijar los fondos 25 y 26.

Passo 05 | Step 05 | Paso 05

Alinhar as molduras 18 na parte de trás da lateral 2, em seguida fixar com parafusos B.  
Align the 18 frames on the back of the side of the side 2, then fix with bolts B.  
Alinee los 18 cuadros en la parte posterior del lado del lado 2, luego fije con pernos B.

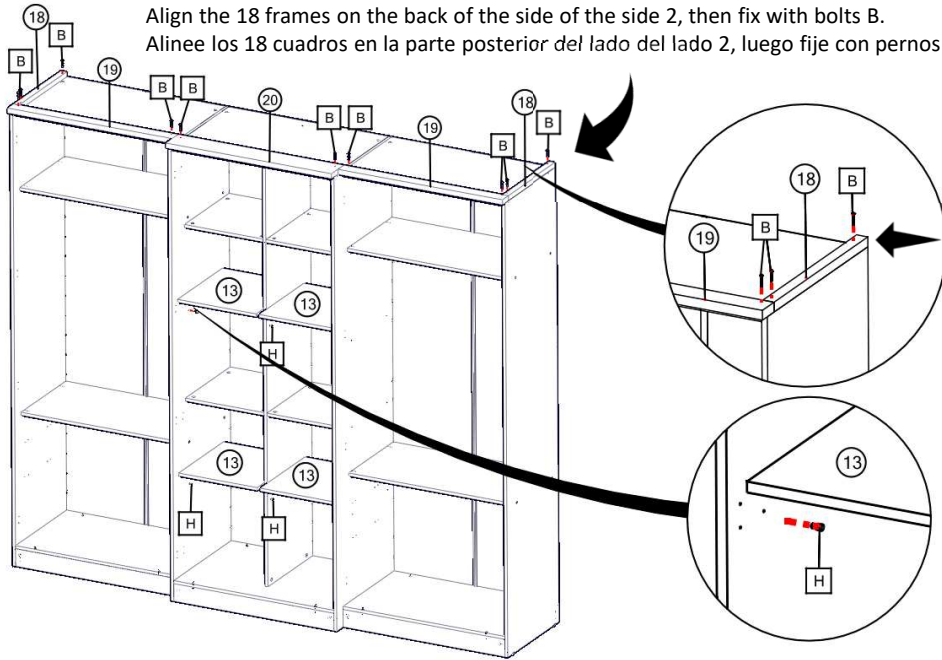

Passo 06 | Step 06 | Paso 06

Utilizar gabarito T para fazer a marcação do suporte cabideiro.  
Use a T template to mark the coat rack support.  
Utilice una plantilla en T para marcar el soporte del perchero.

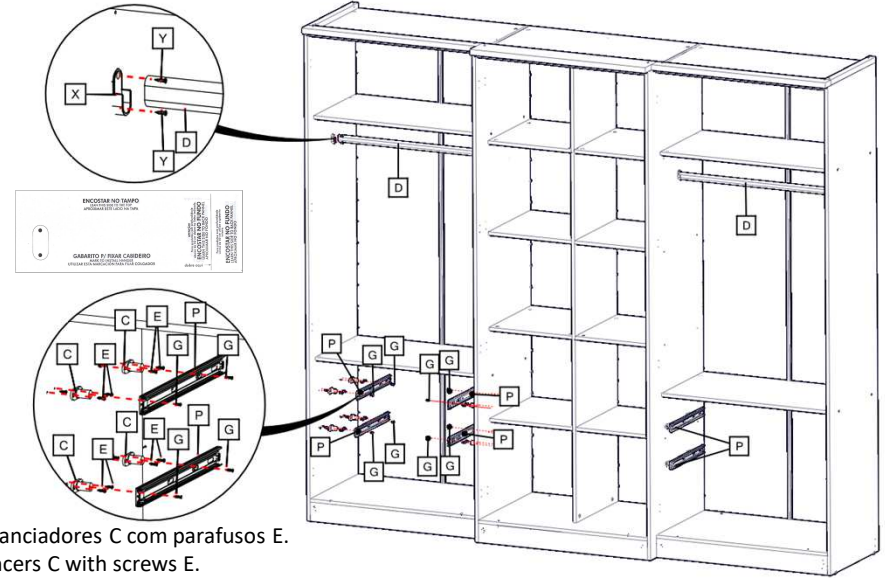

Fixar distanciadores C com parafusos E.  
Fix distancers C with screws E.  
Fix Distancers C con tornillos E.

Passo 07 | Step 07 | Paso 07

Peso suportado pelo produto | Weight supported by the product | Peso apoyado por el producto

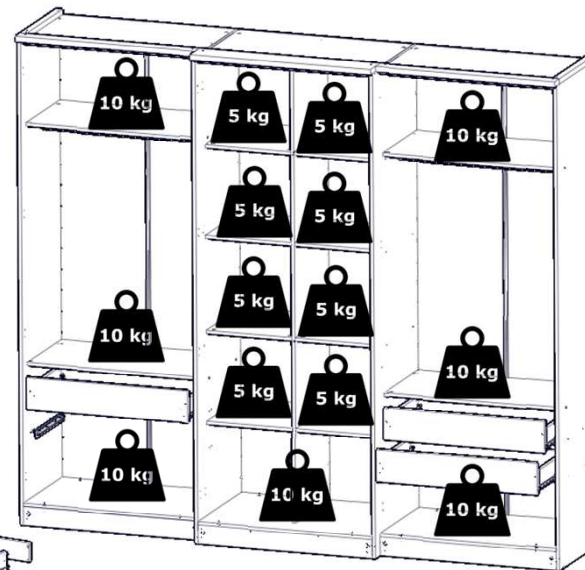
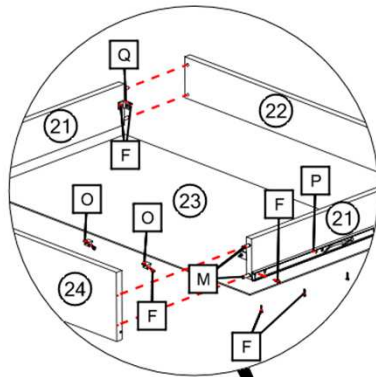

Peso suportado por gaveta.  
Weight supported by drawer.  
Peso soportado por el cajón.

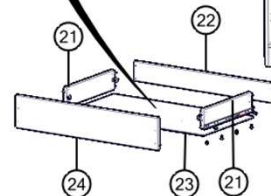

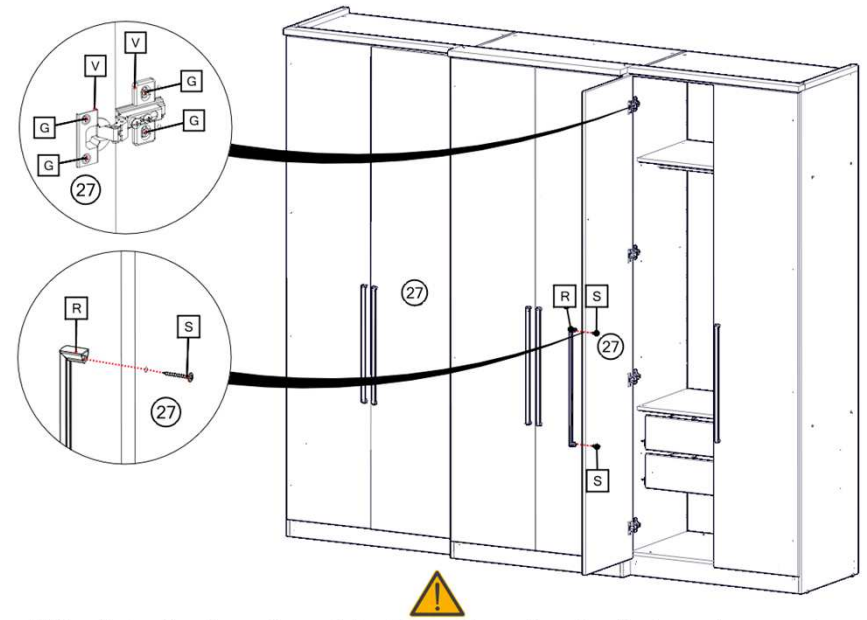
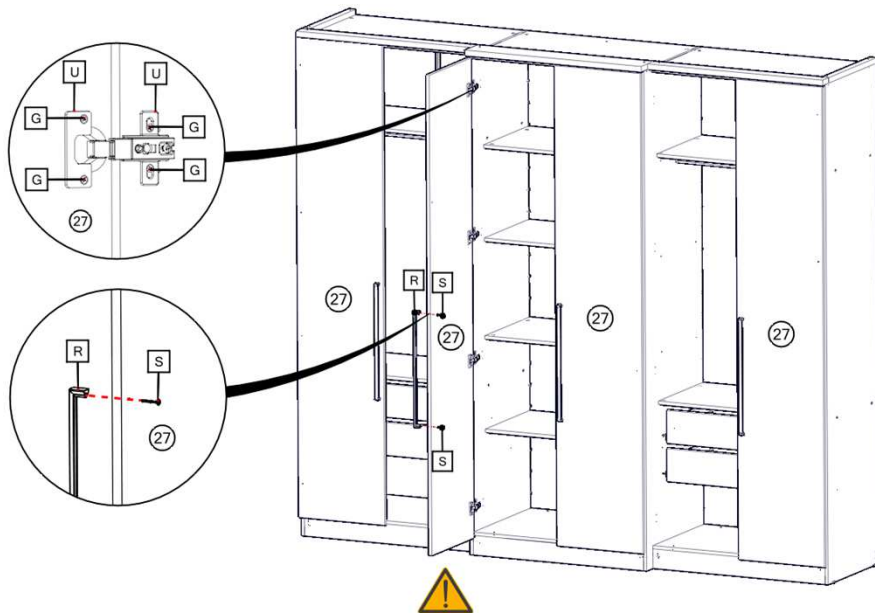

Na fixação das portas centrais e laterais 27 utilizar dobradiça curva+calço U e parafusos G.  
 When fixing the central and side doors 27 use a curved hinge+U shim and G screws.  
 En la fijación de las puertas central y laterales 27 utilice una bisagra curva+calce U y tornillos G.

Utilizar Dobradiça Super Curva+Calço V e parafusos G na fixação das portas recuadas.  
 Use the Super Curve Hinge + Shim V and G screws to fix the recessed doors.  
 Use los tornillos Super Curve Hinge + Shim V y G para fijar las puertas empotradas.

**Baviera Glass**

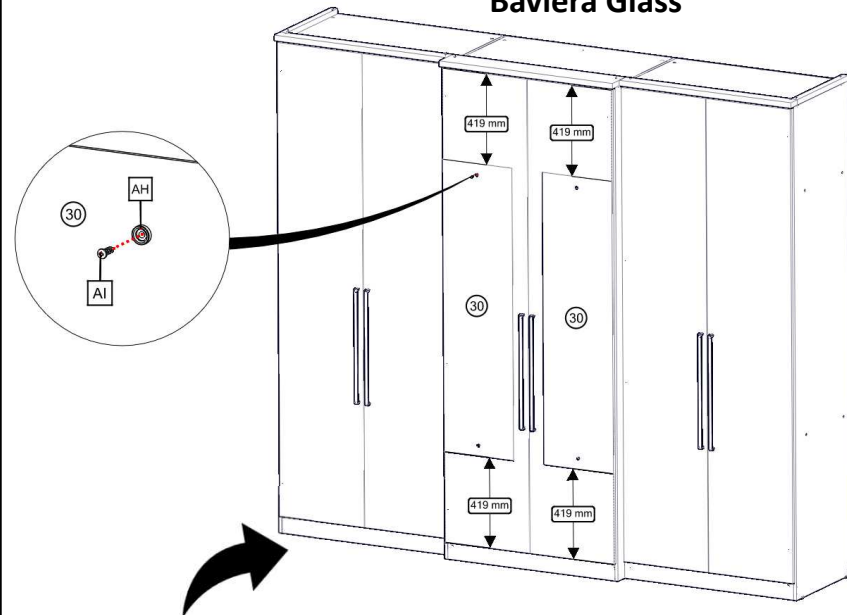

Alinhar o espelho 30 na lateral da porta e centralizá-lo deixando 419 mm do topo. Logo fixar o espelho 30 com suporte AH e parafusos AI.  
 Align the mirror 30 on the side of the door and center it leaving 419 mm from the top. Then fix the mirror 30 with support AH and screws AI.  
 Alinee el espejo 30 en el costado de la puerta y céntralo dejando 419 mm desde la parte superior. Luego fije el espejo 30 con el soporte AH y los tornillos AI.

Alinhe o espelho 28 e 29 a lateral da porta. Em seguida fixa-los com suporte AJ e parafuso AK, deixando um espaço de 2mm entre os espelhos.  
 Align mirror 28 and 29 to the side of the door. Then fix them with AJ support and AK screw, leaving a space of 2mm between the mirrors.  
 Alinee los espejos 28 y 29 en el costado de la puerta. Luego fijelos con soporte AJ y tornillo AK, dejando un espacio de 2mm entre los espejos.

**Baviera Full Glass**

